

This is Theraspace!
What's ***Your Superpower?***



theraspace

Theraspace *range of massage table*

Designed with therapists and their patients in mind, the Theraspace range of massage tables. These tables are an integral part of the daily therapy routine and will be the focal point of any practice. Combining modernity, functionality, and unrivalled comfort, the Theraspace range provides the perfect working tool for therapists and a positive experience for their patients, thanks to advanced technology and careful design.

We provide you with exceptional products designed to help you work with your patients on a daily basis.

3 Year Warranty

This catalogue contains information on a medical device that should be handled by qualified medical personnel and used in accordance with the instructions for use or the label.



For the **comfort and convenience** of your work

The table is an integral part of the therapist's daily work. In order to maintain an ergonomic posture and minimize the risk of musculoskeletal injuries, it is essential to choose the right table and adjust it optimally during treatment. The customizable table settings offered by the Theraspace table provide comfort for both the therapist and the patient and support the efficiency of the work, which in turn has a positive impact on the overall course of the therapy.



Electric actuator with LINAK® IRS™ technology



Mobility provided by 4 castors that allow the table to be moved and repositioned



Easy and stepless adjustment of table sections



One-touch lowering of the armrest in the head section



Bringing

*functionality &
comfort*

to your office

Remote control



Comfortable double layered lying surface

Theraspace upholstery

*- a perfect blend of durability,
comfort, and aesthetics*

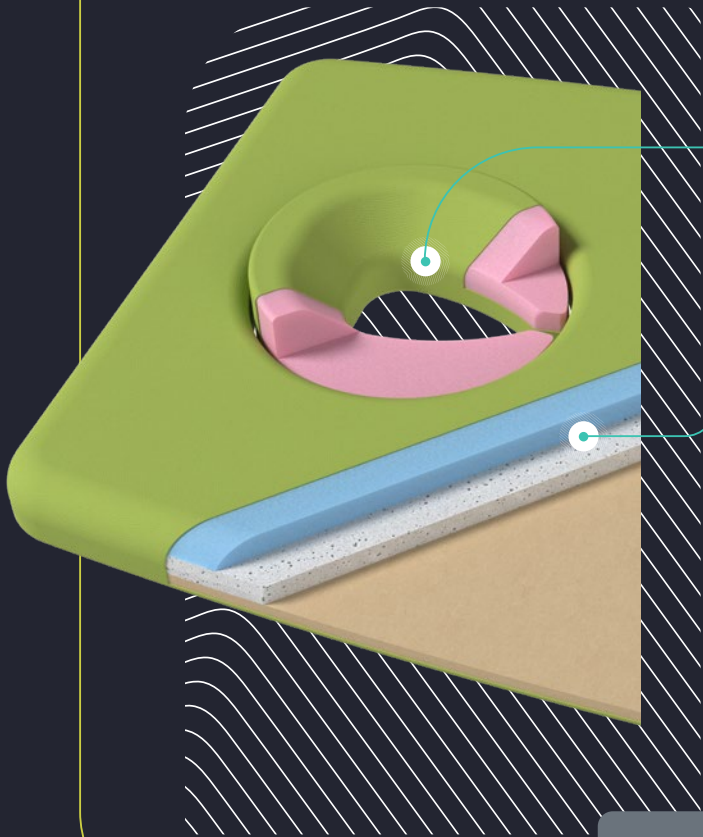

Thanks to its polyurethane (PU) coating, the tables are resistant to scratches or water and offer easy maintenance. Our in-house R&D team has developed the Theraspace upholstery, combining two specially selected foam layers with varying densities and resilience to prevent deformation under pressure. Available in both standard and premium versions, Theraspace tables come with two upholstery types:

- Stretched - S series
- Stitched - Z and X series

Stretched upholstery is perfect for environments requiring frequent cleaning, offering effortless maintenance and hygiene. Stitched upholstery features a more intricate leg structure, providing a refined, more sophisticated appearance.

Both upholstery types are crafted from our exclusive foam composition, which includes two layers with varying densities and elasticities. The stitched upholstery offers a more progressive level of firmness.



The tables can be optionally equipped with a heated lying surface featuring two temperature settings, ensuring patient comfort throughout the treatment session. To protect against overheating, the heating system automatically switches off after 90 minutes, offering peace of mind during use.



Gas spring - easy adjustment of headrest and leg section

The gas spring-assisted mechanism allows for effortless adjustment of the head and leg section tilt angles. To adjust, simply press and hold the gas spring lock lever, reposition the section, and release the lever to automatically lock it in place. This intuitive system ensures the table is precisely and safely adjusted to meet therapy needs, providing ease and reliability with every use.

Smart4Arms - a secure and effortless solution for locking the armrest height adjustment.

Theraspace tables feature the Smart4Arms mechanism, enabling quick and easy one-handed height adjustment of the armrests. Simply tilt the armrest slightly to adjust the height freely. The armrest locks automatically at the desired height once released, ensuring secure positioning with minimal effort.





AutoLock - ensures protection against accidental changes in table position

Theraspace tables can be optionally equipped with a locking function that activates automatically after 10 seconds of remote control or buttons inactivity. An audible signal indicates activation, ensuring added safety and confidence during use.

Remote control – equipped with a memory function to store and recall up to 3 table positions

Theraspace tables can be optionally equipped with a remote control featuring a memory function for three position settings. This allows quick adjustments without unnecessary interruptions, enhancing convenience for both patients and physiotherapists. The function improves comfort, reduces session times, and ensures seamless workflow.



LINAK® IRS™

- Enhancing safety for both patients and therapists

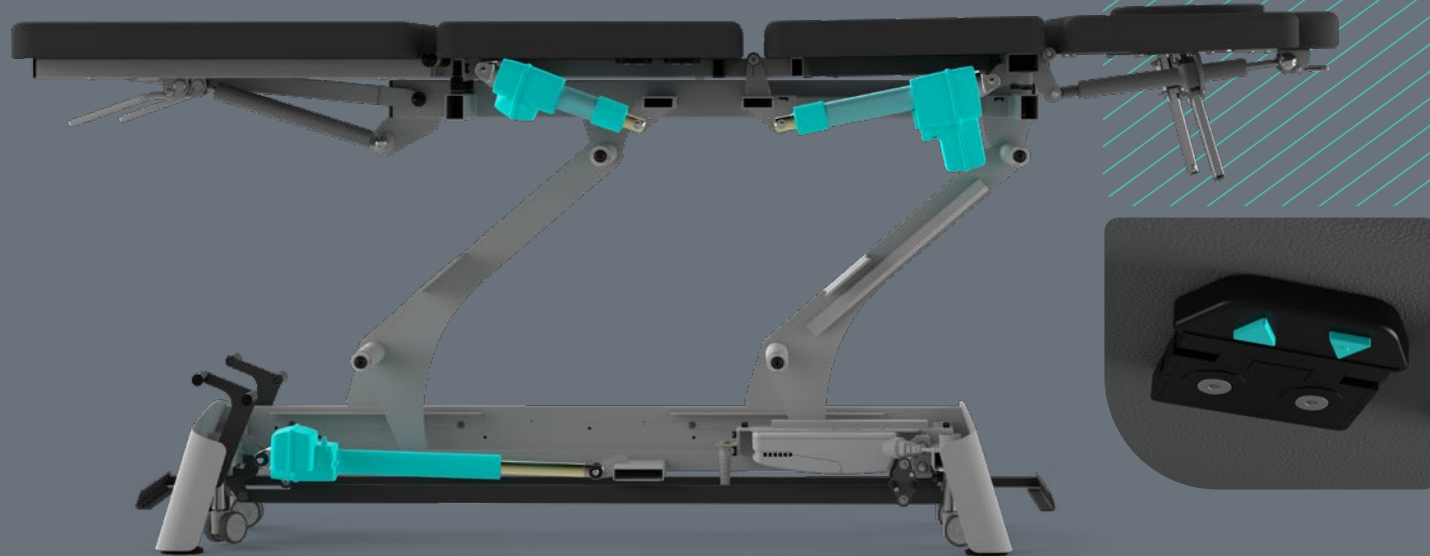

Theraspace tables are equipped with the IRS™ system (LINAK® IRS™), which enhances safety by automatically halting adjustment mechanisms if resistance is detected, such as a patient's limb or the therapist's leg. To prevent injury or damage, the actuator immediately stops and reverses direction, slightly raising the lying surface to safely release the obstruction. This system not only increases user safety but also minimizes potential damage to the table, ensuring reliability and safety during treatment sessions.

Taking care of your patients

Patients are interested in more than just the outcome of their treatment. They also want to feel comfortable, safe, and secure during treatment. The Theraspace tables makes it all possible.





Soft, pleasant to the touch upholstery, made of polyurethane in a range of colors.



Stability during the treatment session.

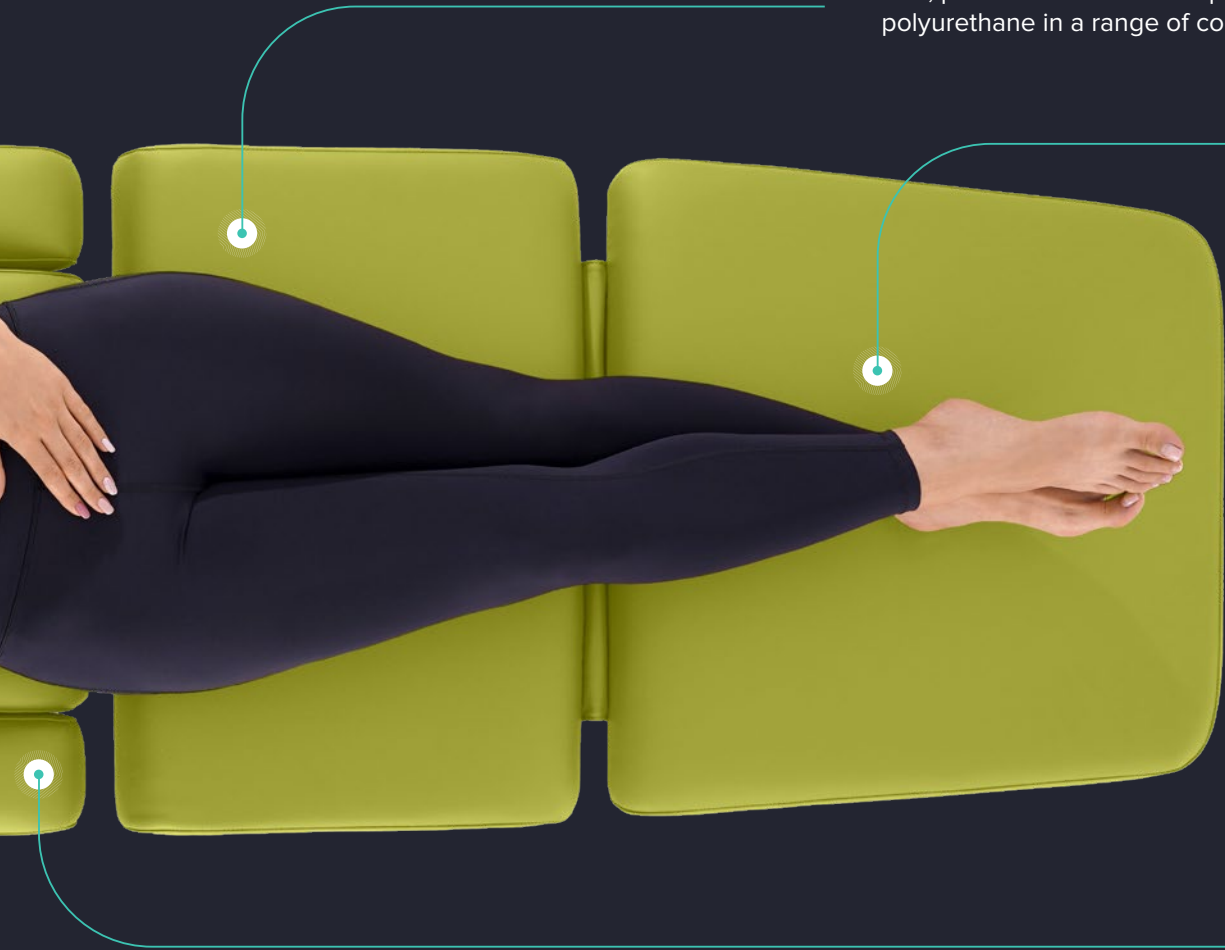

Folding side section for better access to the patient



Face opening for comfort and convenience during treatment with a soft foam crescent-shaped plug.

The wide range of Theraspace tables

It is up to you to decide what kind of table you want to have in your office. Choose the one that best meets your requirements. The wide range of tables in the Theraspace range gives you plenty to choose from.

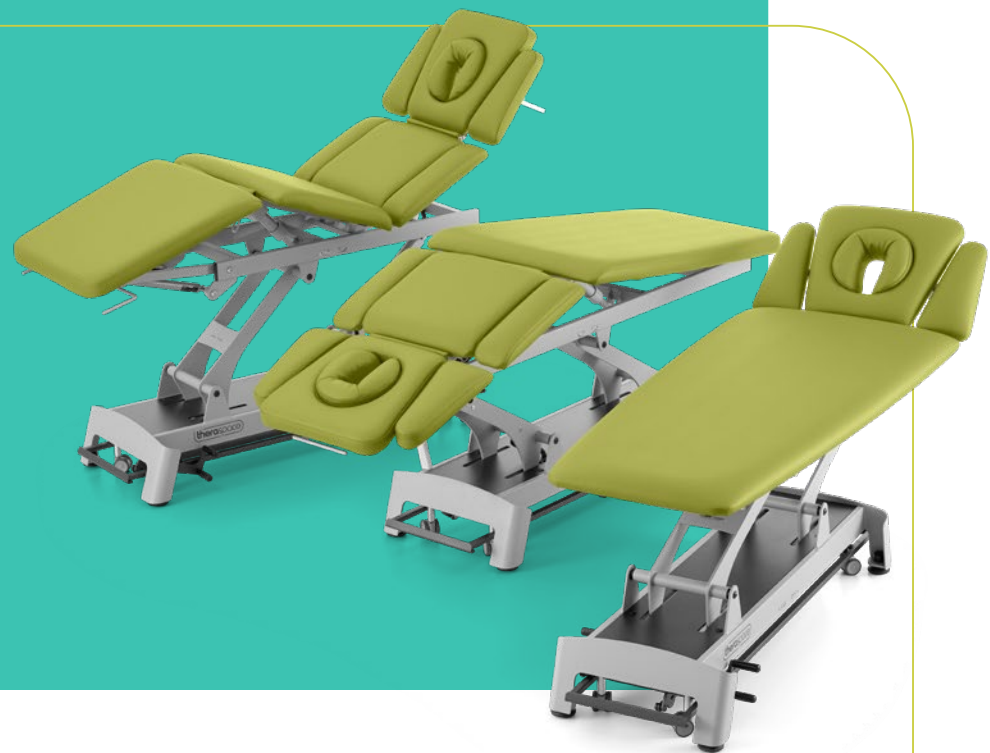

S range

E-S2



S2



S4



Z range

Z3



Z5



Z7



X range

X4



X6



X8



E-S2

2-section massage table with
extended head section

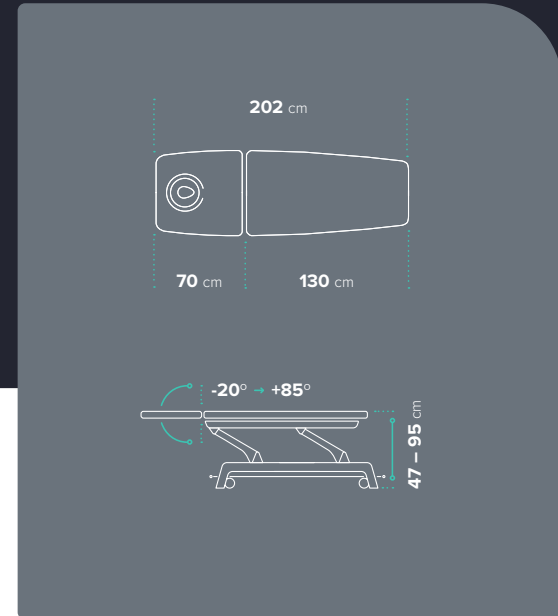

Features:

- Stretched polyurethane upholstery
- 2-ply upholstery foam
- Heated upholstery (optional)
- Round face hole with 2 types of plugs (round, crescent)
- Electric actuator with LINAK® IRS™ technology
- AutoLock - Accidental movement protection / automatic control lock (optional)
- Gas spring head section tilt adjustment
- 4 retractable swivel castors
- SWL during (for) lifting and lowering - 200 kg
- SWL of the table - 275 kg



S2

2-section massage table

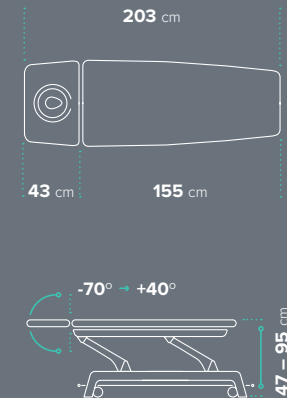

Features:

- Stretched polyurethane upholstery
- 2-ply upholstery foam
- Heated upholstery (optional)
- Round face hole with 2 types of plugs (round, crescent)
- Electric actuator with LINAK® IRS™ technology
- AutoLock - Accidental movement protection / automatic control lock (optional)
- Gas spring head section tilt adjustment
- 4 retractable swivel castors
- SWL during lifting and lowering - 200 kg
- SWL of the table - 275 kg
- 2 rails for stabilization belt attachment,
- 2 holes for stabilization support attachment,



S4

4-section massage table

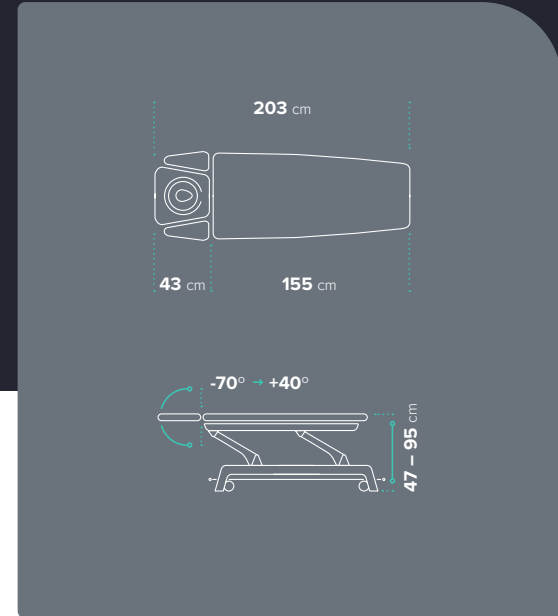

Features:

- Stretched polyurethane upholstery
- 2-ply upholstery foam
- Heated upholstery (optional)
- Round face hole with 2 types of plugs (round, crescent)
- Electric actuator with LINAK® IRS™ technology
- Smart4Arms
- AutoLock - Accidental movement protection / automatic control lock (optional)
- Gas spring head section tilt adjustment
- 4 retractable swivel castors
- SWL during lifting and lowering - 200 kg
- SWL of the table - 275 kg
- 2 rails for stabilization belt attachment
- 2 holes for stabilization support attachment



Z3

3-section massage table



Features:

- Stitched polyurethane upholstery
- 2-ply progressive upholstery foam
- Heated upholstery (optional)
- Round face hole with 2 types of plugs (round, crescent)
- Wireless remote control (optional) with table position memory
- Electric actuator with LINAK® IRS™ technology
- AutoLock - Accidental movement protection / automatic control lock (optional)
- Gas spring head section tilt adjustment
- SWL during lifting and lowering - 200 kg
- SWL of the table - 275 kg
- 4 retractable swivel castors
- Electric tilt adjustment of the head, middle and back sections is operated through control panels located under the lying surface on both sides of the table.

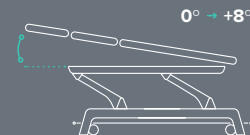
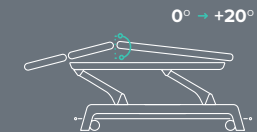
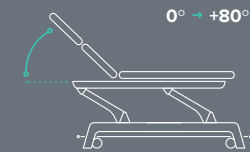
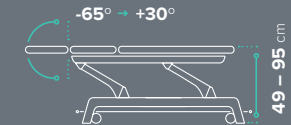
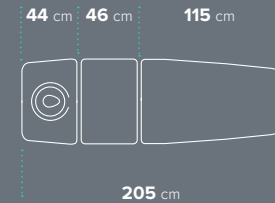

Z5

5-section massage table



Features:

- Stitched polyurethane upholstery
- 2-ply progressive upholstery foam
- Heated upholstery (optional)
- Round face hole with 2 types of plugs (round, crescent)
- Wireless remote control (optional) with table position memory
- Electric actuator with LINAK® IRS™ technology
- Smart4Arms
- AutoLock - Accidental movement protection / automatic control lock (optional)
- Gas spring head section tilt adjustment
- SWL during lifting and lowering - 200 kg
- SWL of the table - 275 kg
- 4 retractable swivel castors
- Electric tilt adjustment of the head, middle and back sections is operated through control panels located under the lying surface on both sides of the table.

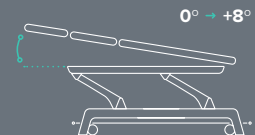
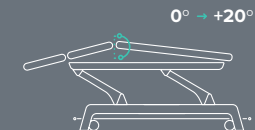
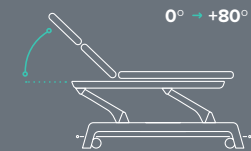
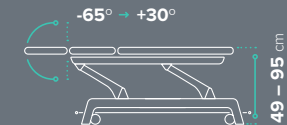
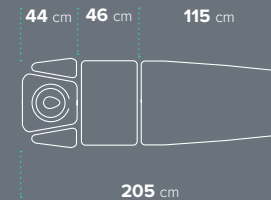

Z7

7-section massage table



Features:

- Folding sides in the center section of the table,
- Stitched polyurethane upholstery
- 2-ply progressive upholstery foam
- Heated upholstery (optional)
- Round face hole with 2 types of plugs (round, crescent)
- Wireless remote control (optional) with table position memory
- Electric actuator with LINAK® IRS™ technology
- Smart4Arms
- AutoLock - Accidental movement protection / automatic control lock (optional)
- Gas spring head section tilt adjustment
- SWL during lifting and lowering - 200 kg
- SWL of the table - 275 kg
- 4 retractable swivel castors
- Electric tilt adjustment of the head, middle and back sections is operated through control panels located under the lying surface on both sides of the table.

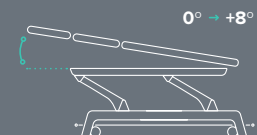
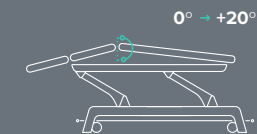
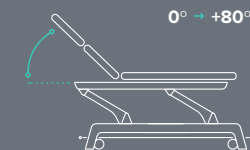
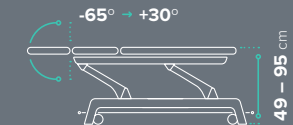
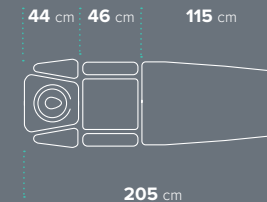

X4

4-section massage table



Features:

- Stitched polyurethane upholstery
- 2-ply progressive upholstery foam
- Heated upholstery (optional)
- Round face hole with 2 types of plugs (round, crescent)
- Wireless remote control (optional) with table position memory
- Electric actuator with LINAK® IRS™ technology
- AutoLock - Accidental movement protection / automatic control lock (optional)
- Gas spring head and leg section tilt adjustment
- SWL during lifting and lowering - 200 kg
- SWL of the table - 275 kg
- 4 retractable swivel castors
- Electric tilt adjustment of the head, middle and back sections is operated through control panels located under the lying surface on both sides of the table.

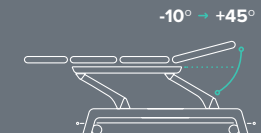
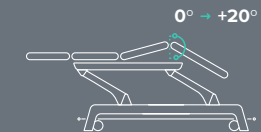
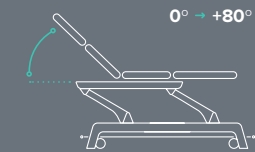
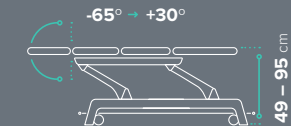
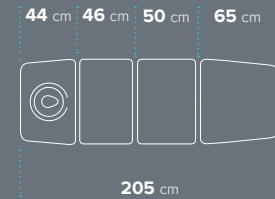

X6

6-section massage table



Features:

- Stitched polyurethane upholstery
- 2-ply progressive upholstery foam
- Heated upholstery (optional)
- Round face hole with 2 types of plugs (round, crescent)
- Wireless remote control (optional) with table position memory
- Electric actuator with LINAK® IRS™ technology
- Smart4Arms
- AutoLock - Accidental movement protection / automatic control lock (optional)
- Gas spring head and leg section tilt adjustment
- SWL during lifting and lowering - 200 kg
- SWL of the table - 275 kg
- 4 retractable swivel castors
- Electric tilt adjustment of the head, middle and back sections is operated through control panels located under the lying surface on both sides of the table.

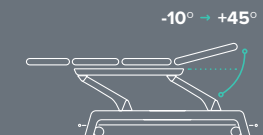
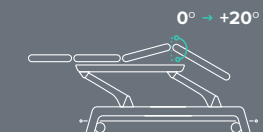
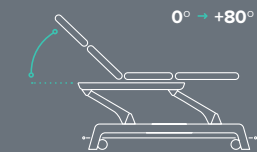
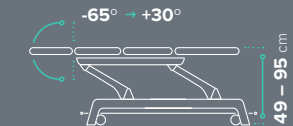
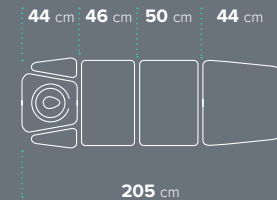

X8

8-section massage table



Features:

- Folding sides in the backrest section of the table,
- Stitched polyurethane upholstery
- 2-ply progressive upholstery foam
- Heated upholstery (optional)
- Round face hole with 2 types of plugs (round, crescent)
- Wireless remote control (optional) with table position memory
- Electric actuator with LINAK® IRS™ technology
- Smart4Arms
- AutoLock - Accidental movement protection / automatic control lock (optional)
- Gas spring head and leg section tilt adjustment
- SWL during lifting and lowering - 200 kg
- SWL of the table - 275 kg
- 4 retractable swivel castors
- Electric tilt adjustment of the head, middle and back sections is operated through control panels located under the lying surface on both sides of the table.

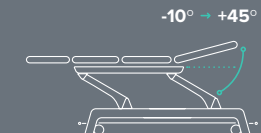
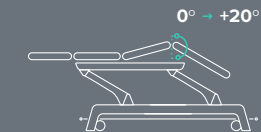
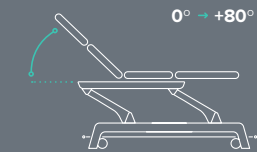
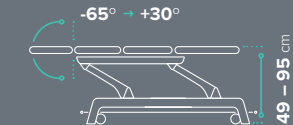
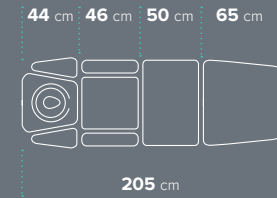

Technical specifications:

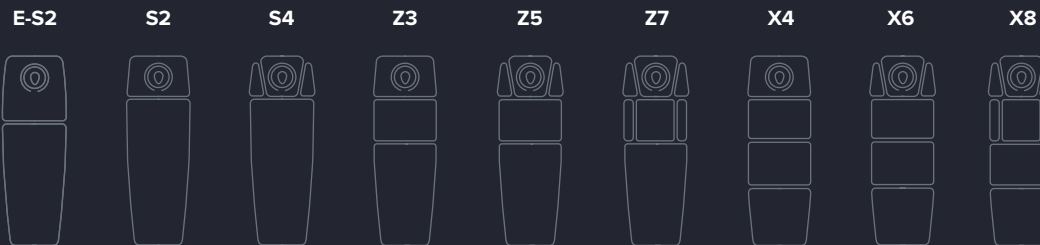

○ Not available ● Available

	E-S2	S2	S4	Z3	Z5	Z7	X4	X6	X8	
Dimensions (L x W) [cm]:	202 x 69	203 x 69	203 x 69	205 x 67	205 x 67	205 x 67	205 x 67	205 x 67	205 x 67	
Weight [kg]:	115	115	115	110	110	110	110	110	110	
Head section tilt adjustment [°]:	-20 → +85	-70 → +40	-70 → +40	-65 → +30	-65 → +30	-65 → +30	-65 → +30	-65 → +30	-65 → +30	
Middle section tilt adjustment [°]:	○	○	○	-20 → 0	-20 → 0	-20 → 0	○	○	○	
Head + middle section tilt adjustment [°]:	○	○	○	0 → +80	0 → +80	0 → +80	○	○	○	
Head + backrest section tilt adjustment [°]:	○	○	○	○	○	○	0 → +80	0 → +80	0 → +80	
Seat section tilt adjustment [°]:	○	○	○	○	○	○	0 → +20	0 → +20	0 → +20	
Leg section tilt adjustment [°]:	○	○	○	0 → +8	0 → +8	0 → +8	-10 → +45	-10 → +45	-10 → +45	
Height adjustment [cm]:	47-95	47-95	47-95	49-95	49-95	49-95	49-95	49-95	49-95	
Maximum safe working load of the table during lifting [kg]:						200				
Maximum safe working load of the table [kg]:						275				
Control panel for tilt adjustment:	○	○	○	●	●	●	●	●	●	
Gas spring (head section):	●	●	●	●	●	●	●	●	●	
Gas spring (leg section):	○	○	○	○	○	○	●	●	●	
Extended head section:	●	○	○	○	○	○	○	○	○	
Smart4Arms:	○	○	●	○	●	●	○	●	●	
Lowered middle / backrest section sides:	○	○	○	○	○	○	●	○	●	
2-ply foam:	●	●	●	○	○	○	○	○	○	
2-ply progressive foam:	○	○	○	●	●	●	●	●	●	
Upholstery (stretched):	●	●	●	○	○	○	○	○	○	
Upholstery (stitched):	○	○	○	●	●	●	●	●	●	
Electrical power supply [V / Hz]:						100-240 / 50-60				

Additional accessories:

Wireless remote control	○	○	○	●	●	●	●	●	●
Paper towel holder:	●	●	●	●	●	●	●	●	●
Foldable horizontal side rails:	●	○	○	○	○	○	○	○	○
Stabilization support:	○	●	●	○	○	○	○	○	○
Stabilization belt:	○	●	●	○	○	○	○	○	○

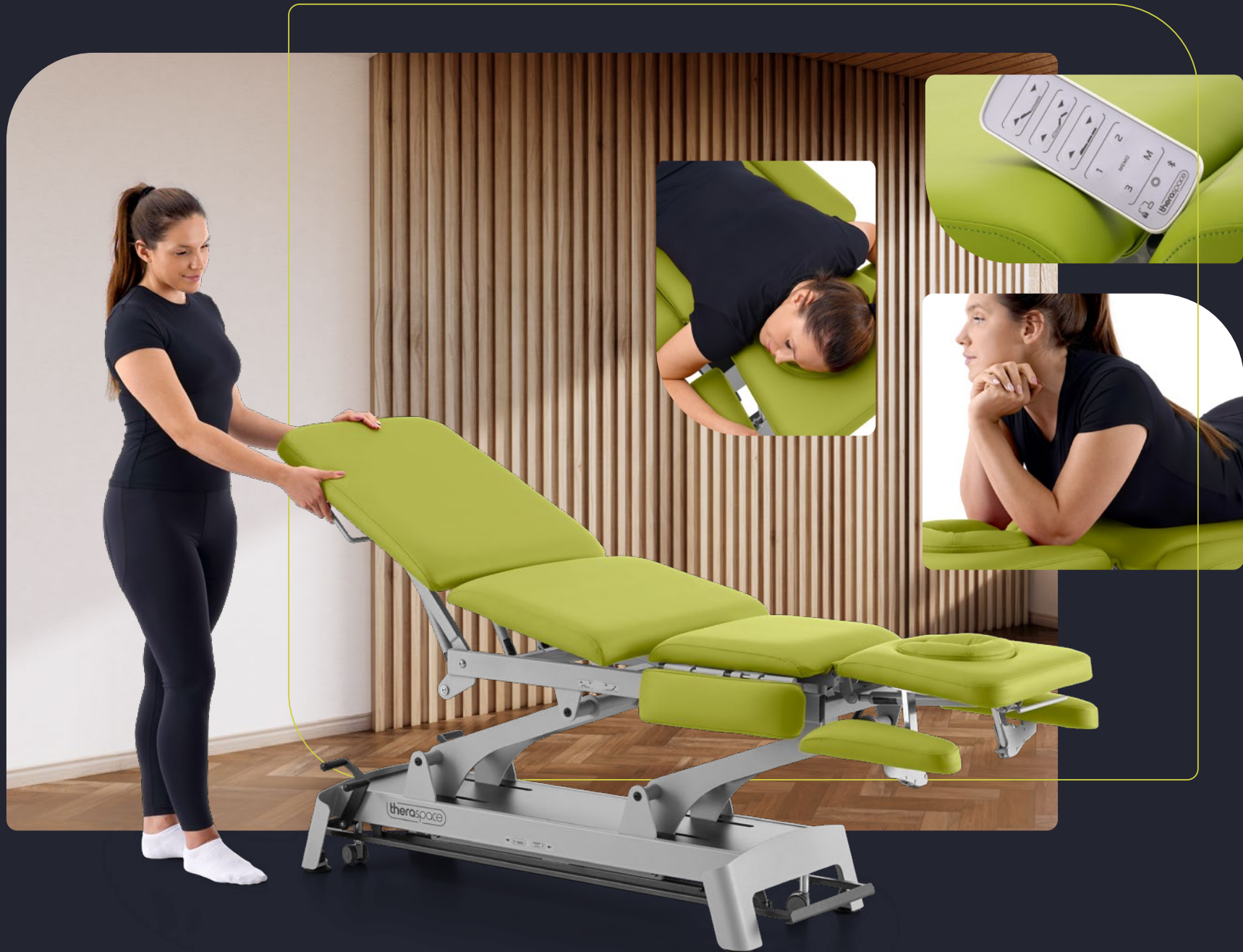

Additional accessories

Additional possibilities

Take advantage of the wide range of accessories available to help you get the most out of working.

Ordering information:

Number:

Description:

01	Paper towel holder*
02	Stabilization support
03	Stabilization belt
04	Kaltenborn wedge (small / large)
05	Wedges
06	Bolsters and semi-bolsters
07	Ergonomic stool for therapist (saddle or round)
08	Foldable horizontal rails (for E-S2)

*Specific holder type depends on the table – for details, contact our customer service or visit online store

When ordering wedges, bolsters, semi-bolsters, stabilization supports or seats, please remember to specify the color of upholstery you require.



01



02



03

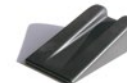

04



05



06



07



08

Range of **LUX upholstery** colors:

Even the most discerning customer will appreciate the wide range of LUX upholstery colors:

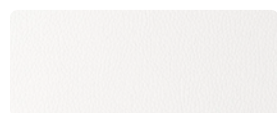

OM006 WHITE

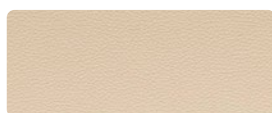

OM240 BEIGE



OM315 SKY



OM221 BLUE



OM314 CEMENT



OM076 OLIVE GREY



OM173 DARK BROWN



OM225 BLACK

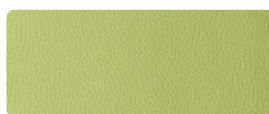

OM469 LIMA

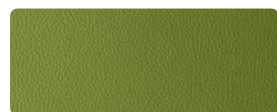

OM157 FOREST



OM053 RED



OM217 BORDEAUX



Resistance to hydrolysis
(8 years)



High scratch resistance



Durability and performance
>500 000 cycles (intensive usage)



Eco-friendly
Does not contain chemical solvents

Cleaning:

Stains or soiling should be removed immediately with a cloth soaked in a neutral soap solution and wiped in a gentle circular motion.

Technical data:

Surface: 100% Polyurethane
Backing: 100% Polyester



Thoughtful design, ergonomics and functional equipment are the hallmarks of a modern practice. Thanks to our many years of experience in the medical sector, we offer comprehensive furnishing solutions for both large rehabilitation centres and small practices. With our passion and professionalism, we will help you to create the perfect working environment - tailored to your specific needs.

en.meden.com.pl/product-catalogues

This catalogue is intended for information purposes only and may not be considered as a commercial offer within the meaning of Article 66 of the Civil Code. The manufacturer reserves the right to modify the design provided that it does not affect the essential functions of the product or safety requirements. In spite of all the efforts made, the colors shown in the catalogue may differ from the actual ones.



Meden-Inmed
2 Wenedów Street, 75-847 Koszalin, Poland
Phone: +48 94 344 90 50, +48 94 347 10 40
Fax: +48 94 347 10 41

international@meden.com.pl
www.en.meden.com.pl

